

Varenummer: 0106047
 Beskrivelse: Seeger låsering JV 30

Mål

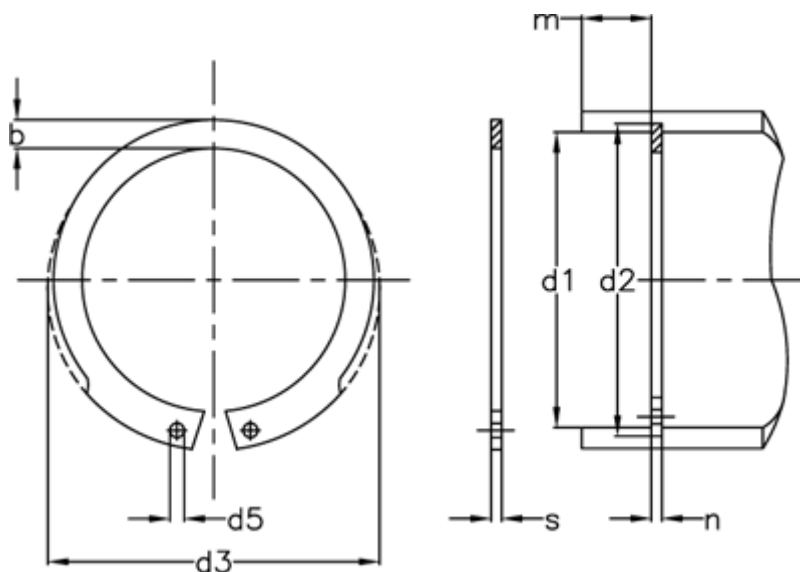

AN mm ²	= 33	FRg kN	= 5.1	Tang	= ZGJ-1
b	= 3.2	FR kN	= 14.9	tol	= -0.06
Betegnelse	= JV 30	g	= 1.0	tol	= +0,50-0,25
d1	= 30	K kN-mm	= 29.0	tol	= +0,25
d2	= 31.4	m min	= 1.30	tol	= 0.1
d3	= 32.1	Nominel træk	= 2.5	vægt kg/1000	= 2.03
d5 min	= 1.5	s	= 1.20		
FN kN	= 5.50	t	= 0.70		